

Project Configuration Sheet – SPV2101-nn

Peripheral Arm Swingarm SP2, 200mm with lockring & Cable Clip Version 1.4

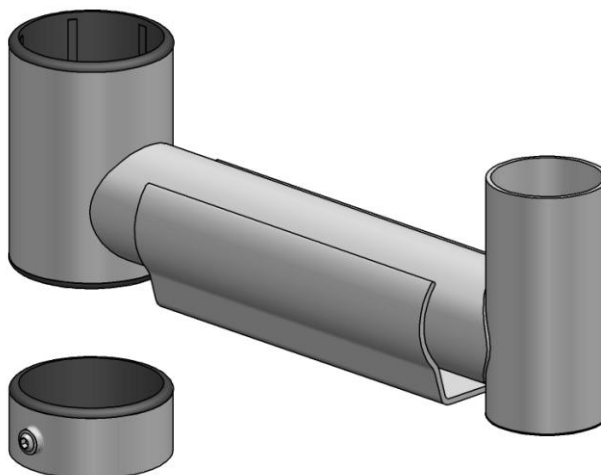

Parts List

Part No.	Description	Qty	Assemble	Box
SP2-2101-200	Swingarm SP2, 200mm with 78mm Endpole	1	1	1
SP2-21210	Lockring SP2	1	1	1
SP2-P22700-0125	Cable Clip SP2, 125mm	1	1	1

Installation Guide

MK15-0174

Box 36x packed in Master Box B007

Box Label MK15-0029 – SPV2101-nn – V 1.4 (place on each item)
MK15-0026 – 36x SPV2101-nn, Peripheral Arm – Swingarm SP2, 200mm with Lockring & Cable Clip - V 1.4

Colour	<nn>	01	Light Grey
		02	Black
		03	Silver
		04	Pearl
		05	Iron Grey